

Digital pressure gauge

For general industrial applications

Model DG-10

WIKA data sheet PE 81.66



further approvals
see Page 5

Applications

- Machine building
- Hydraulics and pneumatics
- Pumps and compressors
- Service tasks

Special features

- Measuring ranges from 0 ... 5 to 0 ... 600 bar
- Accuracy $\leq \pm 0.5\% \pm 1$ digit
- Battery operation (2 x 1.5 V AA cell)
- Option: Rotatable instrument head, backlighting



Digital pressure gauge, model DG-10-E

Description

Robust, precise digital indicator

The robust stainless steel case and the battery power enable a flexible operation in various applications and industries. For a precise and quick on-site reading of a pressure value, a digital indicator is the ideal solution. The bar graph display and drag pointer function integrated into the display, as well as retrievable Min/Max peak values, enable effective analysis of the measuring point.

Customised installation

Through its rotatable case, the model DG-10-E can be easily adapted to local conditions. The backlighting also provides easy readability of the display in poor lighting conditions.

Additional programming functions are: Automatic power-off, tare function and password protection. There is unit switching between the units bar, psi and MPa already integrated into the standard model DG-10-S.

Proven sensor technology

For decades, sensors manufactured by WIKA have guaranteed high accuracy, long-term stability and repeatability in industrial pressure measurement.

Measuring ranges

Gauge pressure							
bar	Measuring range	0 ... 5	0 ... 10	0 ... 20	0 ... 50	0 ... 100	0 ... 160
	Overpressure limit	10	20	40	100	200	320
	Burst pressure	12	25	50	120	800	1,000
	Measuring range	0 ... 250	0 ... 400	0 ... 600			
	Overpressure limit	500	800	1,200			
	Burst pressure	1,200	1,700	2,400			
psi	Measuring range	0 ... 145	0 ... 300	0 ... 600	0 ... 1,450	0 ... 2,000	0 ... 3,000
	Overpressure limit	290	580	1,450	2,900	4,640	7,250
	Burst pressure	360	725	1,740	11,600	14,500	17,400
	Measuring range	0 ... 5,000	0 ... 7,500	0 ... 10,000¹⁾			
	Overpressure limit	11,600	17,400	21,750			
	Burst pressure	24,650	34,800	43,500			

1) DG-10-S can only display up to 9999 psi

Vacuum and +/- measuring ranges			
bar	Measuring range	-1 ... +5	-1 ... +10
	Overpressure limit	10	20
	Burst pressure	12	25
psi	Measuring range	-30 inHg ... +72 psi	-30 inHg ... +145 psi
	Overpressure limit	145	290
	Burst pressure	170	360

Digital indicator

	Model DG-10-S	Model DG-10-E
Type of indication	7-segment LCD	7-segment LCD 14-segment LCD (option)
Digits	4-digit	4 ½-digit
Character size	11 mm	11 mm and 7 mm
Indication range	-1999 ... 9999	-1999 ... 19999
Update	200 ms	200 ms
Backlighting	no	yes (see "Hardware functions")
Bar graph with drag pointer function	yes	yes
Rotatability	no	300° (see "Hardware functions")

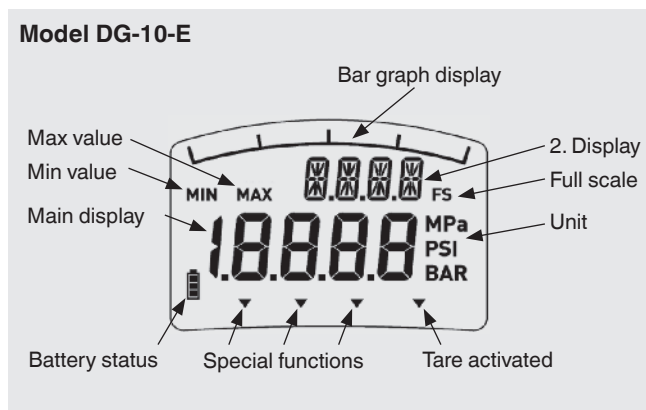
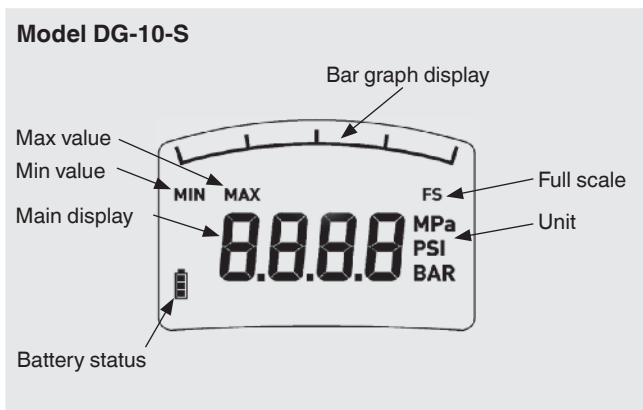

Software functions

Function	Model DG-10-S	Model DG-10-E
Min/Max memory	yes	yes
Automatic power-off	no	15, 30, 60, 120 minutes
Tare function	no	yes
Unit switching	bar, psi, MPa	bar, psi, MPa
Password protection	no	yes
Reset to factory settings	no	yes

Hardware functions

Rotatability of the display

The display of the model DG-10-E can be rotated through 300°, thus it can be read from almost any position. Therefore the model DG-10-E can also be used in situations where mounting is difficult.



Backlighting

The model DG-10-E features backlighting so that the display can be easily read, even under poor lighting conditions.



Voltage supply

The voltage supply is provided via two 1.5 V AA cells.

The operating time is approx. 4,000 hours, when using batteries with a capacity of 2,000 mAh.

Reference conditions

Temperature

0 ... 60 °C (32 ... 140 °F)

Atmospheric pressure

860 ... 1,060 mbar (12.5 ... 15.4 psi)

Humidity

< 90 % r. h. (non-condensing)

Nominal position

Calibrated in vertical mounting position with process connection facing downwards.

Power supply

2 x 1.5 V AA cell

Accuracy

Accuracy at reference conditions

$\leq \pm 0.5$ % of span ± 1 digit ¹⁾

1) Restriction for vacuum and +/- measuring ranges in the range of -1 ... 0 bar
 $\leq \pm 1.0$ % of span ± 1 digit

Including non-linearity, hysteresis, zero offset and end value deviation (corresponds to measured error per IEC 61298-2).

Calibration accuracy of zero signal

$\leq \pm 0.1$ % of span (power-up reset)

Adjustability of zero point

$\leq \pm 20$ % of span (via tare function with model DG-10-E)

Temperature error at 0 ... 60 °C

- Mean temperature coefficient of zero point
 $\leq \pm 0.15$ % of span/10 K
- Mean temperature coefficient of span
 $\leq \pm 0.15$ % of span/10 K

Long-term stability

$\leq \pm 0.2$ % of span/year

Operating conditions

Ingress protection (per IEC 60529)

IP65

Temperatures

- Medium: -30 ... +100 °C (-22 ... 212 °F)
- Ambient: -10 ... +60 °C (14 ... 140 °F)
- Storage: -20 ... +70 °C (-4 ... 158 °F)

Process connections

Standard	Thread size
ISO1179-2 (formerly DIN 3852-E)	G ¼ A
EN 837	G ¼ B
	G ½ B
ANSI/ASME B1.20.1	¼ NPT
	½ NPT

Sealings

Process connections to the ISO1179-2 (formerly DIN 3852-E) standard are delivered with NBR sealings as standard.

Materials







Wetted parts

- Process connection: Stainless steel 316Ti
- Sealing material: See "Process connections"
- Sensor element: PH grade steel

Non-wetted parts

- Case: Stainless steel 304
- Front foil and membrane: Polyester

Approvals

Logo	Description	Country
	EU declaration of conformity <ul style="list-style-type: none"> ■ EMC directive EN 61326 emission (group 1, class B) and interference immunity (industrial application) ■ Pressure equipment directive ■ RoHS directive 	European Union
	EAC <ul style="list-style-type: none"> ■ EMC directive ■ Pressure equipment directive 	Eurasian Economic Community
	GOST Metrology, measurement technology	Russia
	KazInMetr Metrology, measurement technology	Kazakhstan
	BelGIM Metrology, measurement technology	Belarus
	UkrSEPRO Metrology, measurement technology	Ukraine
	Uzstandard Metrology, measurement technology	Uzbekistan
-	CRN Safety (e.g. electr. safety, overpressure, ...)	Canada

Approvals and certificates, see website

Dimensions in mm

Digital pressure gauge

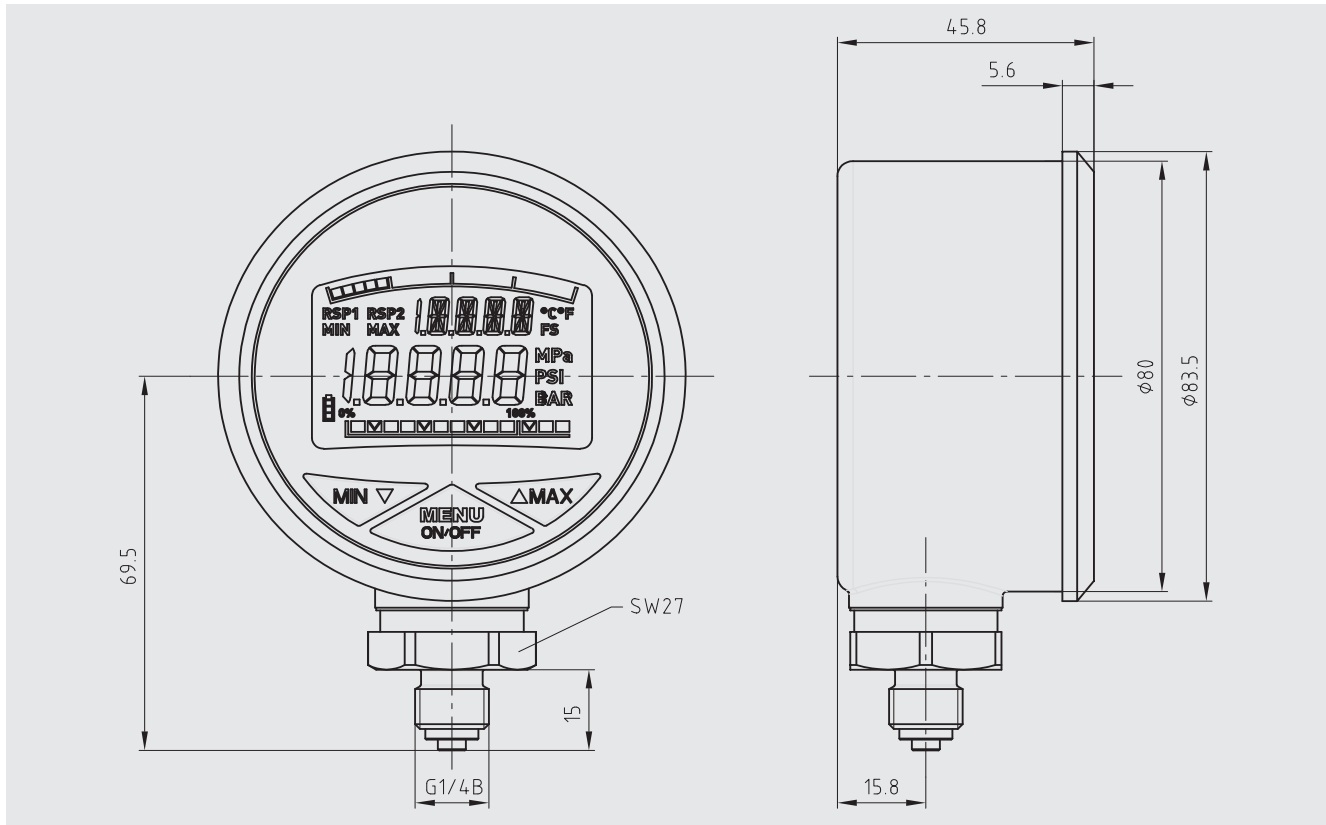

Process connections

**G 1/4 A ISO1179-2
(formerly DIN 3852-E)**

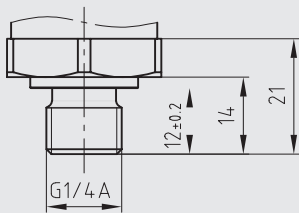

G 1/4 B EN 837

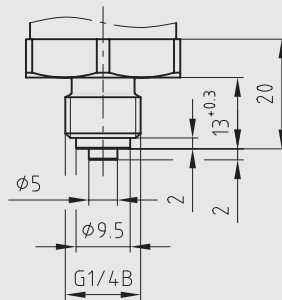

1/4 NPT

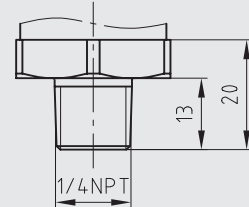

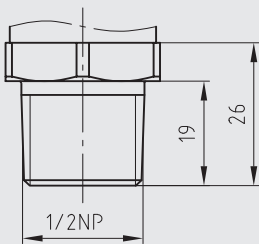

1/2 NPT

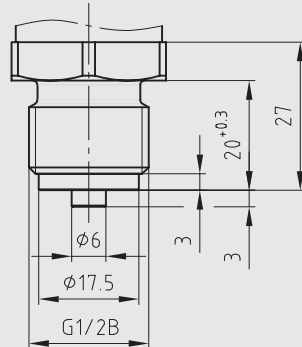

G 1/2 B EN 837



Accessories

	Description	Order number
	Rubber protection cap (black)	11262010
	Minimes connector Maximum pressure strength 630 bar	9072314
	Sealing for process connection per ISO1179-2 (formerly DIN 3852-E) Material NBR Thread size G 1/4 A ISO1179-2 (formerly DIN 3852-E)	1537857

Ordering information

Model / Measuring range / Process connection

© 04/2007 WIKA Alexander Wiegand SE & Co. KG, all rights reserved.
 The specifications given in this document represent the state of engineering at the time of publishing.
 We reserve the right to make modifications to the specifications and materials.

